

1.25Gbps Upstream/1.25Gbps Downstream GE-PON ONU Transceiver

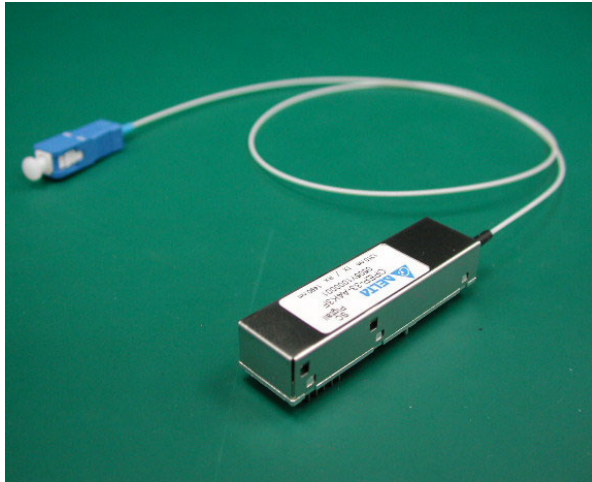

FEATURES

- RoHS compliant
- IEEE802.3ah Gigabit Ethernet compliant
- 2x5 pin SFF package with SC pigtail fiber
- 1310nm Burst Mode 1.25Gbps transmitter, and 1490nm Continuous Mode 1.25Gbps receiver
- Integrated with WDM filter to cut 1550nm and 1650nm optical signal off
- Single +3.3V power supply
- LVTTTL Bias Control input and Rx Signal Detect output
- Laser Class 1 Product which comply with the requirements of IEC 60825-1 and IEC 60825-2

Description

DELTA's GE-PON ONU transceiver **OPEP-33-A4K3R** is designed for Gigabit Ethernet Passive Optical Network transmission.

The module is contained in a 2x5 SFF package with a 9/125um SC pigtail single mode fiber.

The module consists 1310nm DFB laser, InGaAs PIN, Preamplifier and WDM filter in a high-integrated optical sub-assembly, and it receives up to 1.25Gbps of continuous data at 1490nm, and transmits 1.25Gbps of burst-mode data at 1310nm.

Application

- IEEE 802.3ah 1000BASE-PX20-U
- GE-PON ONU
- Burst Mode Application
- FTTx WDM Broadband Access
- OPEP-33-A4K3R data link up to 20km in 9/125um single mode fiber.

1. Absolute Maximum Ratings

Parameter	Symbol	Min.	Typ.	Max.	Unit	Note
Storage Temperature	T _s	-40		85	°C	
Storage Ambient Humidity	HA	5		95	%	
Power Supply Voltage	V _{CC}	-0.3		4	V	
Signal Input Voltage		-0.3		V _{CC} +0.3	V	
Receiver Damage Threshold		+7			dBm	
Lead Soldering Temperature	T _{SOLD}			260	°C	
Lead Soldering Time	t _{SOLD}			10	sec	

2. Recommended Operating Conditions

Parameter	Symbol	Min.	Typ.	Max.	Unit	Note
Ambient Operating Temperature	T _A	0		70	°C	Without air flow
Ambient Humidity	HA	5		95	%	Non-condensing
Power Supply Voltage	V _{CC}	3.13	3.3	3.47	V	
Power Supply Current	I _{CC}			300	mA	
Power Supply Noise Rejection				100	mVp-p	100Hz to 1MHz
Data Rate		1.25 -100ppm	1.25	1.25 +100ppm	Gbps	
Transmission Distance				20	km	

3. Specification of Transmitter

Parameter	Symbol	Min.	Typ.	Max.	Unit	Note
Average Launched Power (B.O.L)	P _O	0		+4	dBm	Note (1)
Average Launched Power (E.O.L)	P _O	-0.5		+4.5	dBm	Note (1)
Launched power (Peak.)	P _P			+7.5	dBm	
Extinction Ratio	ER	9			dB	
Center Wavelength	λ _c	1260	1310	1360	nm	DFB Laser
Spectrum Width (-20dB)	σ	Compliant with IEEE 802.3ah			nm	Note (4)
Side Mode Suppression Ratio	SMSR	30			dB	
Transmitter OFF Output Power	P _{Off}			-45	dBm	
Laser Burst On Time	T _{on}			32	ns	
Laser Burst Off Time	T _{off}			32	ns	
Optical Rise/Fall Time	t _r /t _f			260	ps	Note (2)
Total Jitter	t _J			128	ps	Note (3)
Optical Return Loss Tolerance	ORLT			15	dB	
Relative Intensity Noise	RIN ₁₅ OMA			-115	dB/Hz	
Optical Transmitter Reflectance				-10	dB	
Transmitter and Dispersion Penalty	TDP			1.8	dB	
Output Eye Mask {X1,X2,Y1,Y2,Y3}	Compliant with IEEE 802.3ah {0.22,0.375,0.20,0.20,0.30}					Note (5)

Note (1). Launched power (avg.) is power coupled into a single mode fiber with master connector.

B.O.L=Before of Life; E.O.L= End of Life

Note (2). These are unfiltered 20-80% values.

Note (3). Measure at 2⁷-1 NRZ PRBS pattern

Note (4): Spectral Width (RMS)

Center Wavelength	RMS spectral width(max) 1000Base-PX20-U
nm	nm
1260	0.72
1270	0.86
1280	1.07
1290	1.40
1300	2.00
1304	2.42
1305	2.55
1308	3.00
1317	
1320	2.53
1321	2.41
1330	1.71
1340	1.29
1350	1.05
1360	0.88

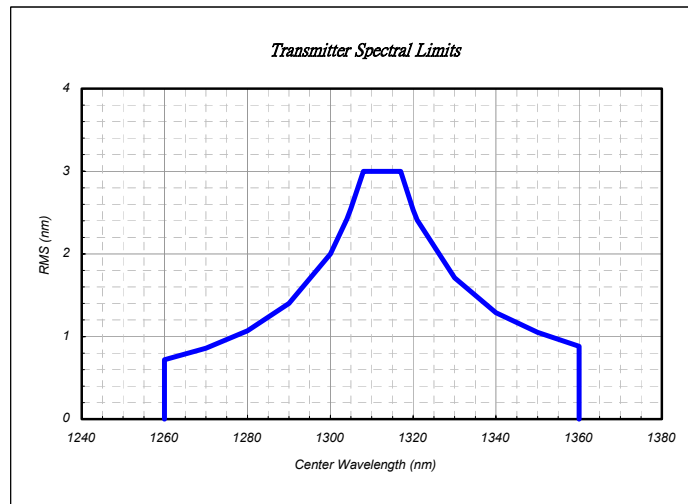

Note (5). Transmitter eye mask definition

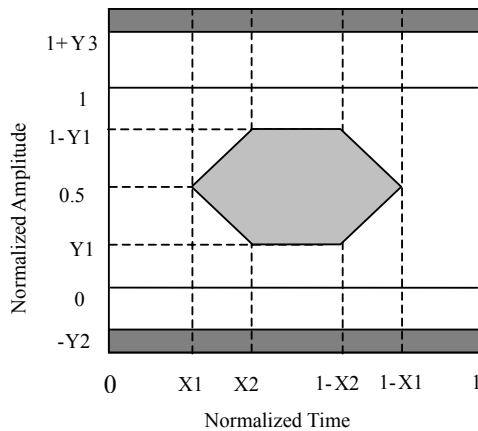

4. Specification of Receiver

Parameter	Symbol	Min.	Typ.	Max.	Unit	Note
Input Optical Wavelength	λ_{IN}	1480	1490	1500	nm	PIN-PD
Receiver Sensitivity	P_{IN}			-26	dBm	Note (1)
Input Saturation Power (Overload)	P_{SAT}	-3			dBm	
Signal Detect -Assert Power	P_A	-		-26	dBm	
Signal Detect -Deassert Power	P_D	-44			dBm	Note (2)
Signal Detect Hysteresis	$P_A - P_D$	0.5	2	6	dB	
Data Output Rise/Fall time	t_r/t_f			260	ps	Note (3)
Receiver Reflectance	1480 to 1500nm			-12	dB	Note (4)

Optical Isolation from External Source	1260 to 1360nm				-43	dB	
	1550 to 1560nm				-33	dB	
	1640 to 1665nm				-33	dB	

Note (1). Measured with Light source +1dBm, 1490nm, ER=9dB; BER = $<10^{-12}$ @ PRBS = 2^7-1 NRZ

This assurance should be met with asynchronous data flowing out of the optical transmitter of the system under test. The output data pattern from the transmitter of the system under test is a repetition of alternate 0/1 pattern as defined for this measurement.

Note (2). When SD deasserted, the data output is Low-level (fixed)

Note (3). These are 20%~80% values.

Note (4). Measured at wavelength of 1490nm.

5. Electrical Interface Characteristics

Parameter	Symbol	Min.	Typ.	Max.	Unit	Note
Transmitter						
Total Supply Current	I_{CC}			A	mA	Note (1)
Differential line input Impedance	R_{IN}	80	100	120	Ohm	
Differential Data Input Swing	V_{DT}	400		1600	mV_{p-p}	Note (2)
BiasCNT Input Voltage- High	V_{BCH}	2		V_{CC}	V	LVTTTL
BiasCNT Input Voltage- Low	V_{BCL}	0		0.8	V	
Receiver						
Total Supply Current	I_{CC}			B	mA	Note (1)
Differential Data Output Swing	V_{DR}	400		900	mV_{p-p}	Note (2)
Signal Detect Output Voltage-High	V_{LOSH}	2		$V_{CC}+0.3$	V	LVTTTL
Signal Detect Output Voltage-Low	V_{LOSL}	0		0.8	V	

Note (1). A (TX)+ B (RX) = 300mA (Not include termination circuit)

Note (2). Internally AC coupled, but requires a 100Ohm differential termination at or internal to Serializer/Deserializer.

6. Transmitter Burst Mode Timing Characteristics

Parameter	Symbol	Min.	Typ.	Max.	Unit	Note
BiasCNT Enable Duration		1			us	
Interval of BiasCNT Signal		0.112		1000000	us	

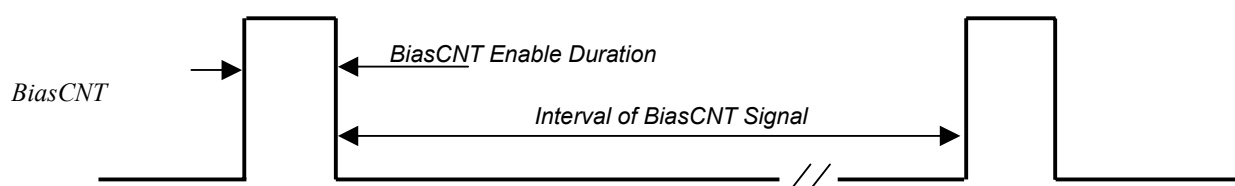

VccT	BiasCNT	Data Input	Optical Output
VccT < 3.1V	X	X	OFF
VccT > 3.1V	Low	X	OFF
	High	No	Other
Yes		Laser bias and modulation signal output	

X = Don't care

Other = Less than +7.5dBm (peak)

High = Logic high level, Low = logic low level

No = No Data Input, Yes = Data Input,

OFF = Optical Power is less than -45dBm

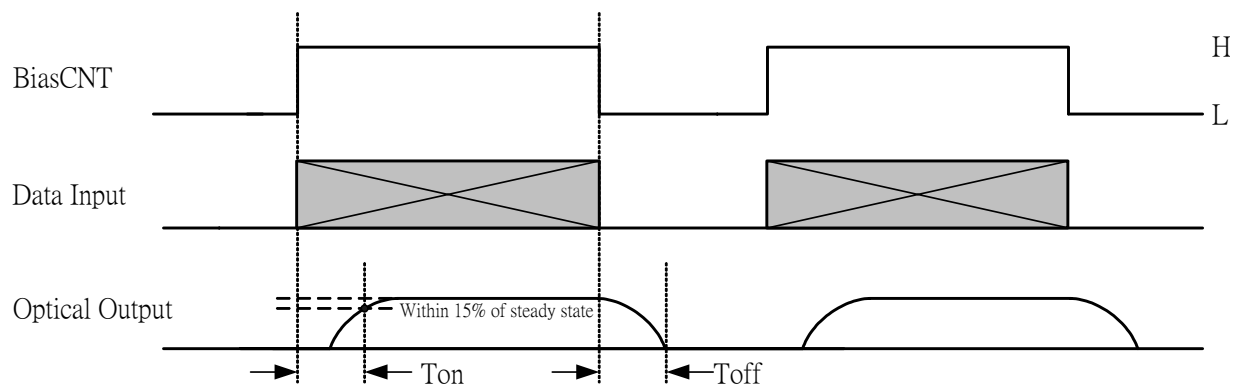

7. Pin Description

Tx/Rx	Pin No.	I/O	Pin Name	Description
Rx	1		VeeR	Receiver Ground
	2		VccR	+3.3V Receiver Power Supply
	3	O	SD	Normal Optical Input indicated by logic "High", and No Optical Input indicated by logic "Low". (LVTTTL)
	4	O	RD(n)	Inverted Receiver Data Output (AC-Coupled CML output)
	5	O	RD(p)	Non-Inverted Receiver Data Output (AC-Coupled CML output)
Tx	6		VccT	+3.3V Transmitter Power Supply
	7		VeeT	Transmitter Ground
	8	I	BiasCNT	Positive pulse which control the ONU burst mode operation
	9	I	TD(p)	Non-Inverted Transmitter Data Input (AC-Coupled LVPECL input)
	10	I	TD(n)	Inverted Transmitter Data Input (AC-Coupled LVPECL input)
			MS	Mounting studs/ connect this pin to Chassis ground

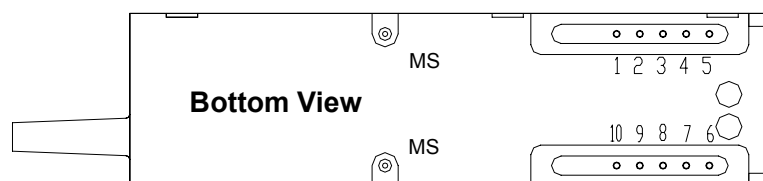

8. Recommended Interface Circuit

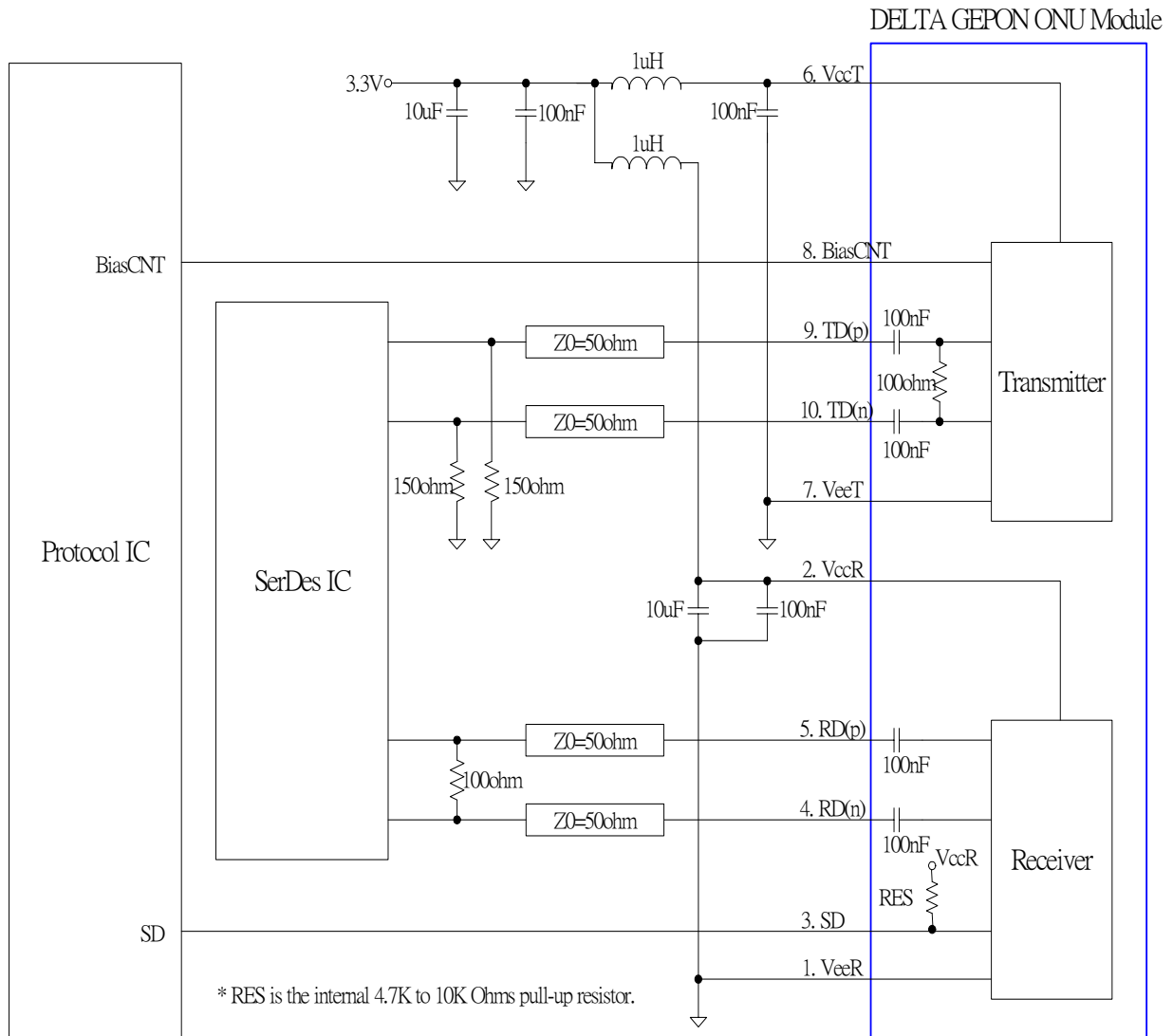

9. Outline Dimensions

Parameter	Unit	Description	Note
Mechanical Dimensions	mm	49.5x13.34x9.6	
Connector Type	-	SC/UPC connector	IEC-61754-4
Minimum Fiber Bending Radius	mm	20	
Maximum Fiber Contact Temperature	°C	85	
Tensile Force on Pigtail	Kg	1	
Maximum Fiber Stress Allowance	kpsi	200	
Fiber length (L)	mm	540 +/-20	

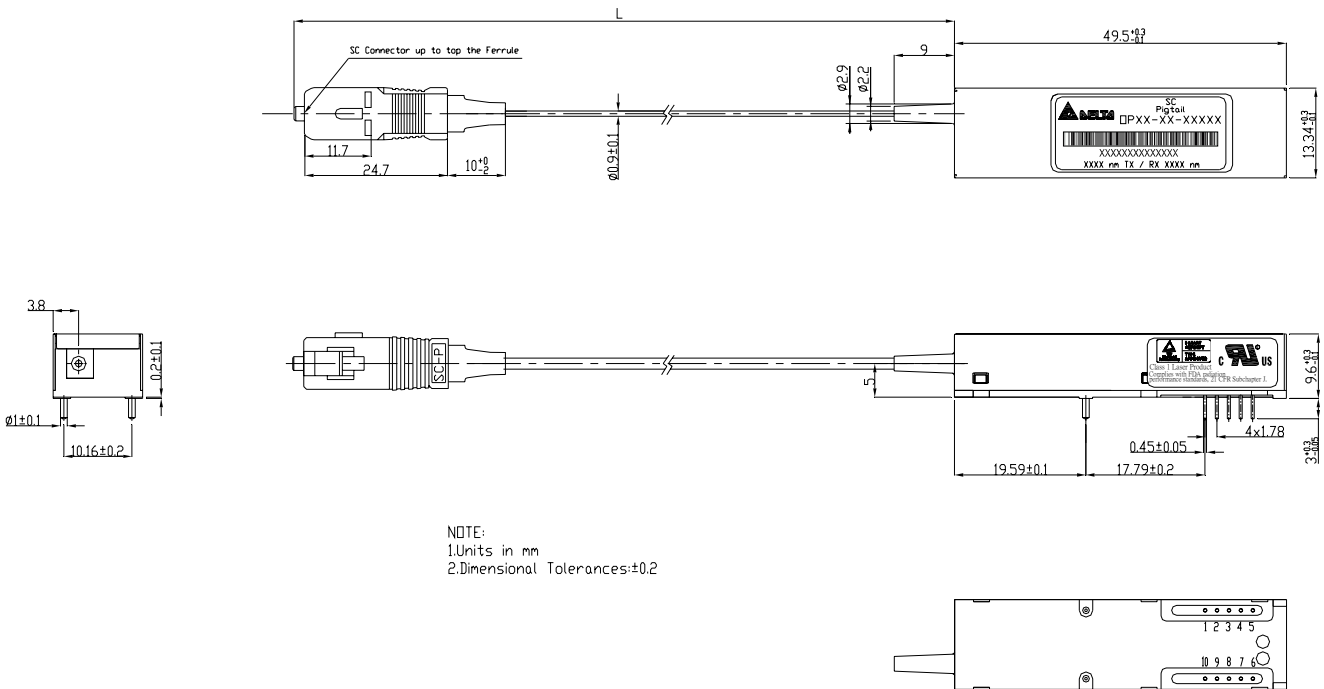

NOTE:
 1.Units in mm
 2.Dimensional Tolerances:±0.2

S/ N

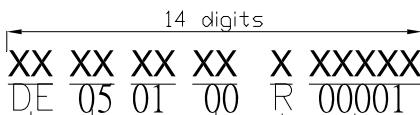

S/N : (00001~99999)
 Rework : Rework=R or No-rework=0
 Vender NOTE : Free or 00
 Week (52Weeks/Year) : 1月2日=01
 Year : 2005=05
 Vender CODE : DELTA=DE

10. Regulatory Compliance

Feature	Test Method	Reference	Performance
Electrostatic Discharge (ESD) to the Electrical Pins	Human Body Model (HBM)	MIL-STD-883E Method 3015.7 EIA-JESD22-A114	(1) Satisfied with electrical characteristics of product spec. (2) No physical damage
	Machine Model (MM)	EIA-JESD22-A115	
Electrostatic Discharge (ESD) to the Simplex Receptacle	Contact Discharge	IEC/EN 61000-4-2	
	Air Discharge	IEC/EN 61000-4-2	
Radio Frequency Electromagnetic Field Immunity		IEC/EN 61000-4-3	
Electromagnetic Interference (EMI)		FCC Part 15 Class B EN 55022 Class B (CISPR 22A)	
Laser Eye Safety	FDA/CDRH	FDA 21CFR 1040.10, 1040.11	CDRH File # 0420993
	TUV	IEC/EN 60825-1 IEC/EN 60825-2	TUV Certificate # R50032471
Component Recognition	TUV	IEC/EN 60950	
	UL/CSA	UL 60950	UL File # E239394

Appendix A. Document Revision

Version No.	Date	Description
S0	2006-08-15	Preliminary datasheet
S1	2007-03-12	Revised datasheet- Optical Rise/Fall Time and Differential Data Output Swing